



**PRODUCT FEATURES**

- 1, 2, 3, or 4 parallel slots integrated into a coated steel plenum for return applications
- Matching return for Model SCD Supply Diffuser
- 3/4", 1", 1-1/2" slot widths
- 24", 36", 48", 60" nominal lengths

**CONSTRUCTION DETAILS**

- Material:** 24 GA Zinc-Coated Steel
- Finish:** Flat black on exposed Diffuser Face surfaces (**std**)  
Factory attached T-Bars are white
- Custom Colors (opt)

**MODELS**

- SCR-L** All center Tees included
- SCR-L-N** 2' x 2' Crossover, All center Tees included (notch in center of 4' plenum)
- SCR-LX** Straddle (2 slot only - NO center Tee). Unit includes notched end caps for grid member.
- SCR-LX-N** Combination Crossover and Straddle feature (2 slot only)

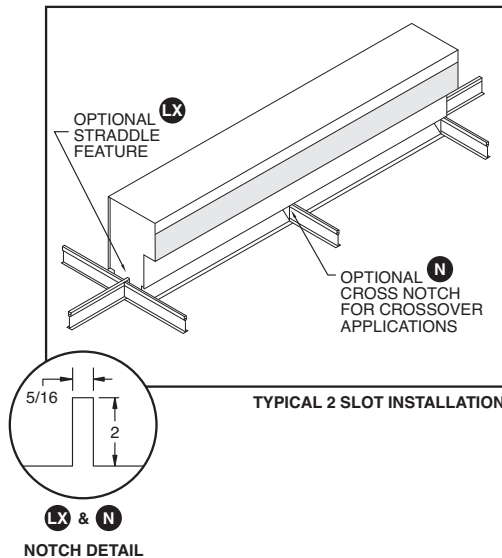
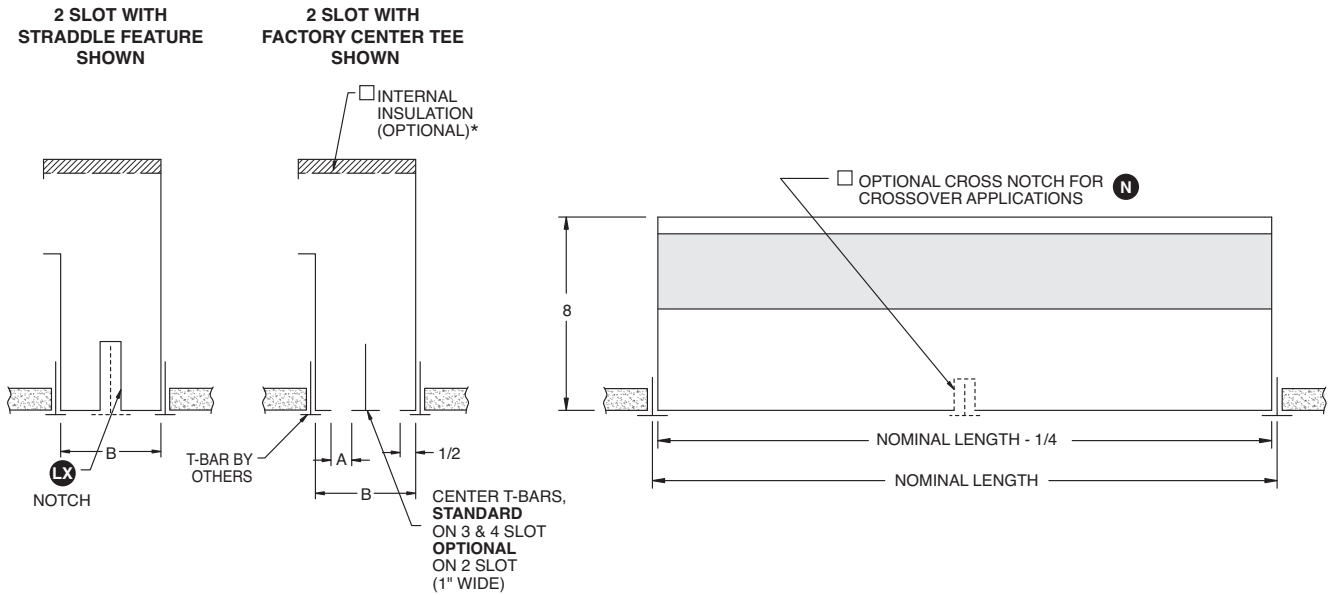

SLOT WIDTH A	B				NOM LENGTH
	1-SLOT	2-SLOT	3-SLOT	4-SLOT	
<b>SCR-75</b>	3/4"	1-3/4	3-1/2	5-1/4	7
<b>SCR-10</b>	1"	2	4	6	8
<b>SCR-15</b>	1-1/2"	2-1/2"	5	7-1/2	10

All dimensions are in inches.

**JOB NAME:**

**SUBMITTED BY:**

**FACTORY INSTALLED SIDE TEES / CLIPS**  
(FACTORY TEES ARE 1" WIDE - WHITE FINISH)

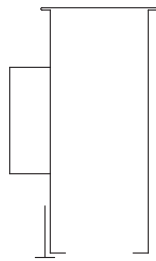

**OPTION 1**  
ONE SIDE TEE  
(INLET SIDE)

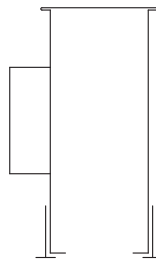

**OPTION 2**  
TWO SIDE TEE

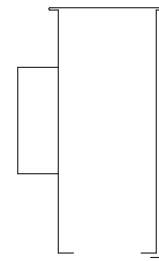

**OPTION 3**  
ONE SIDE TEE  
(NON-INLET SIDE)

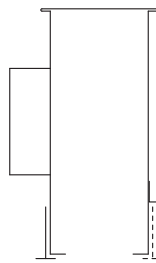

**OPTION A**  
ONE SIDE TEE  
(INLET SIDE)  
+ T-BAR CLIPS

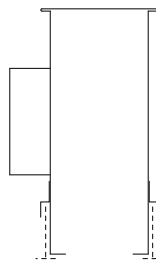

**OPTION B**  
T-BAR CLIPS  
(BOTH SIDES)

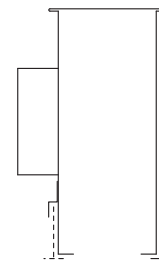

**OPTION C**  
ONE SIDE TEE  
(NON-INLET SIDE)  
+ T-BAR CLIPS

**GRID / CEILING TYPE**

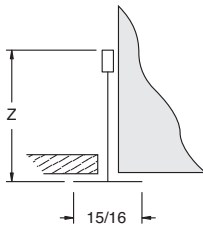

**15/16" LAY-IN**

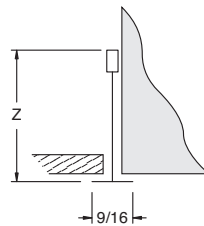

**9/16" LAY-IN**

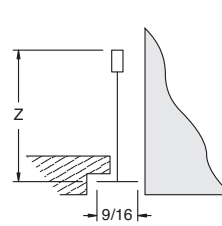

**9/16" TEGULAR**

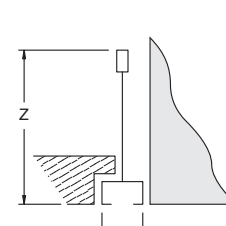

**9/16" NARROW SLOT**

CEILING MANUFACTURER: \_\_\_\_\_

Z = \_\_\_\_\_

MODEL: \_\_\_\_\_

All dimensions are in inches.

**JOB NAME:** \_\_\_\_\_

**SUBMITTED BY:** \_\_\_\_\_