

SUBMITTAL SHEET

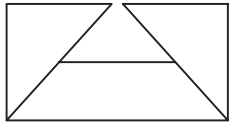

from: **ANEMOSTAT**®

CARSON CA
310-835-7500

MODEL PJCM-200

Pro Jet™
ARCHITECTURAL
LINEAR DIFFUSER
CONCEALED MOUNTING

SINGLE SLOT

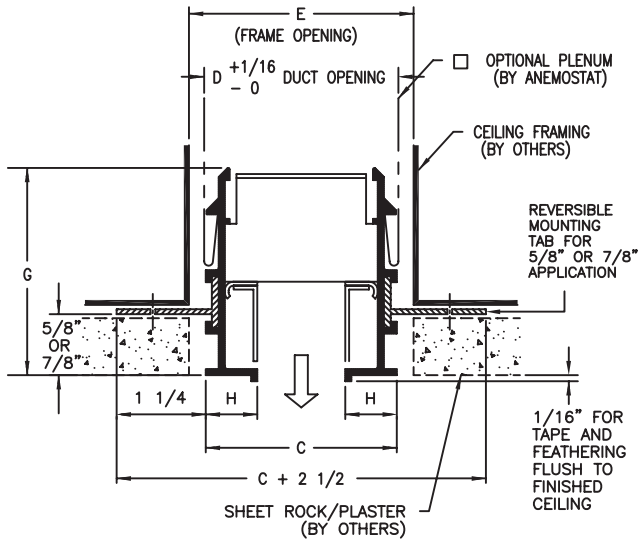

PJCM-200 (2" SLOT WIDTH)						
# OF SLOTS	C	D	E	G	H	J
1	4 5/16	4 5/16	4 5/8	2 11/16	1 5/32	-
2	8 5/16	8 5/16	8 5/8			2
3	12 5/16	12 5/16	12 5/8			
4	16 5/16	16 5/16	16 5/8			

MULTIPLE SLOT

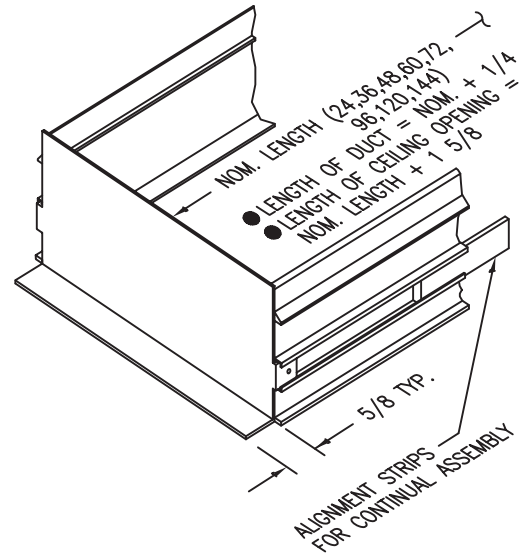
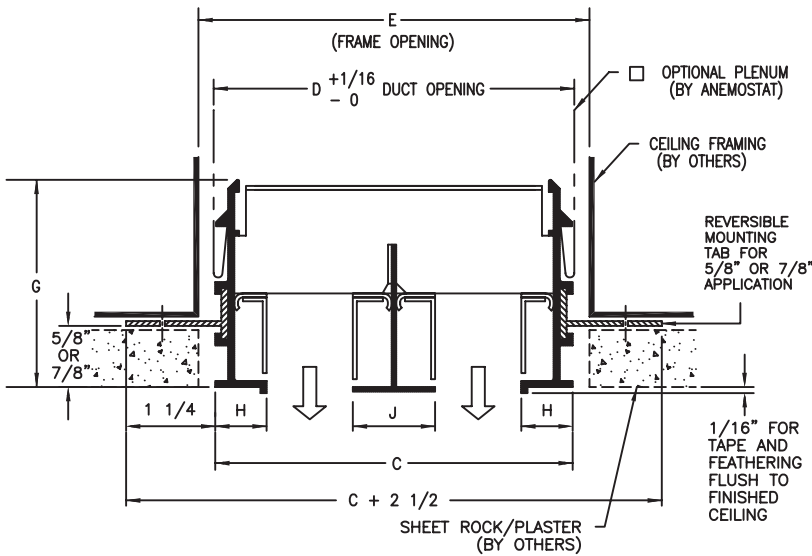

END PLATE DETAIL

MATERIAL: .062 ALUMINUM EXTRUSION
GALVANIZED HARDWARE

FINISH: OUTER FRAME - BLACK
CENTER TEE - WHITE
INTERIOR COMPONENTS - BLACK

ASSEMBLY: ALIGNMENT STRIPS AND MOUNTING
BRACKETS FURNISHED FOR FIELD
ASSEMBLY AND INSTALLATION

PATTERN FLEXIBILITY

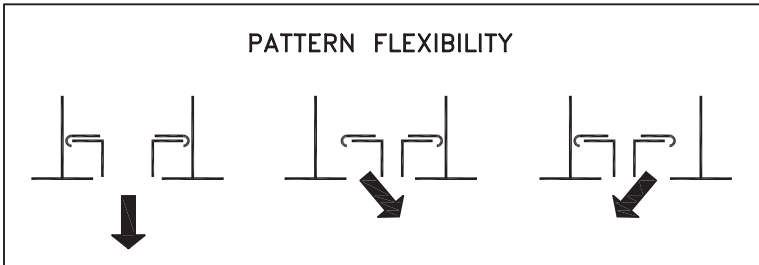

MFG. TOLERANCE ± 1/32

All Dimensions are in Inches

JOB NAME:	SUBMITTED BY:
LOCATION:	
ARCHITECT:	
ENGINEER:	
CONTRACTOR:	
	DWG # LIN-0334
	DATE 3-24-10 REV D