

SUBMITTAL SHEET

www.anemostat-hvac.com

CORE ONLY

PRODUCT FEATURES

- Heavy gauge, extruded aluminum construction
- Lengths to 120"
- Heights from 1-1/2" to 18"

CONSTRUCTION DETAILS

Material: All Aluminum Construction

Finish: Arctic White (std)

- Mill Finish (opt) Natural Anodize (opt)
- Anemostat Color # _____
- Custom Color Match _____

Models

- AL-C-10W** - 1/4" Bars on 1/2" Ctrs. - 0°
- AL-C-15W** - 1/4" Bars on 1/2" Ctrs. - 15°
- AL-C-45W** - 3/16" Bars on 1/2" Ctrs. - 45°
- TL-C-10N** - 1/8" Bars on 1/4" Ctrs. - 0°
- TL-C-10W** - 1/8" Bars on 1/2" Ctrs. - 0°
- TL-C-15N** - 1/8" Bars on 1/4" Ctrs. - 15°
- TL-C-15W** - 1/8" Bars on 1/2" Ctrs. - 15°

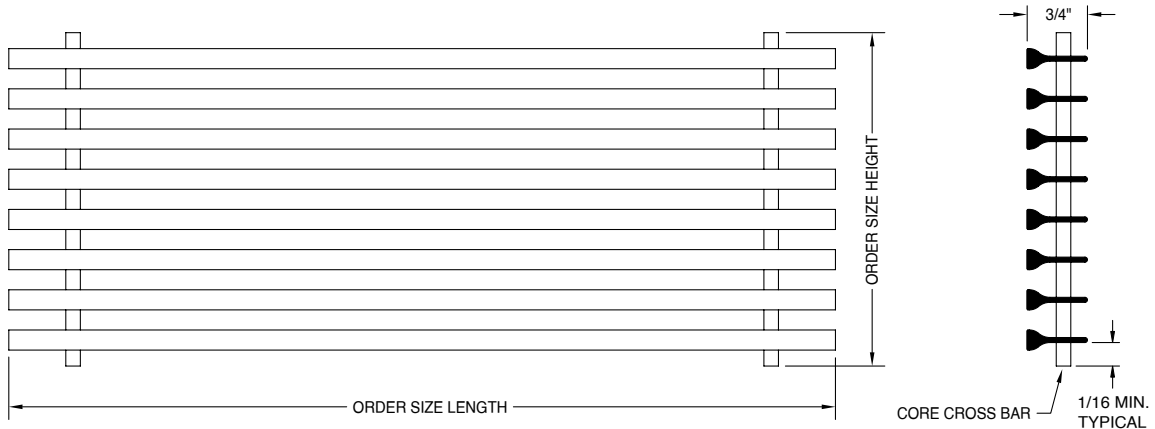

CORE BLADE STYLES

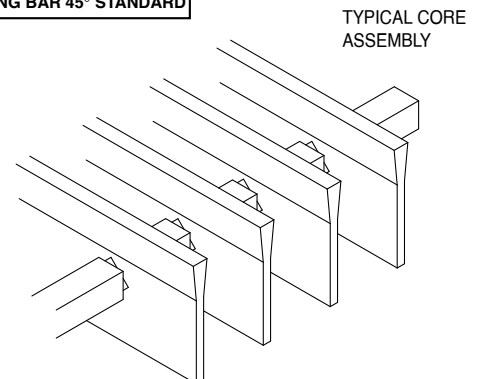
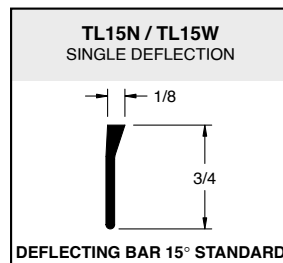
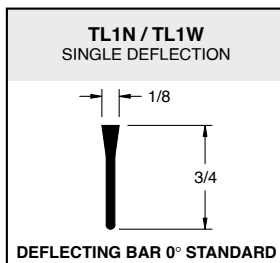
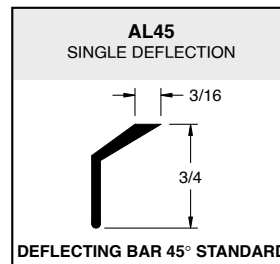
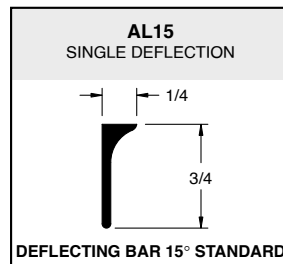
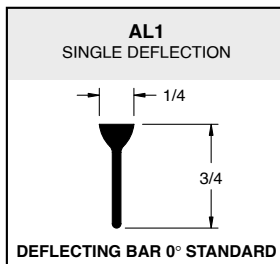

All dimensions are in inches.

JOB NAME:

SUBMITTED BY: