

S-VENT[®]

SUBMITTAL SHEET



Anemostat[®]

A MESTEK COMPANY

P.O. BOX 4938 • 1220 WATSONCENTER ROAD • CARSON, CA 90745-4206
 (310) 835-7500 • FAX (310) 835-0448
 e-mail: airsec@anemostat.com • website: www.anemostat.com

SV2-__-FM

SPECIFY TYPE
MAXIMUM SECURITY GRILLE
 1/8" X 1/8" OPENING
 with
 FACE MOUNTED GRILLE
 and PLATE

TOP SECTION

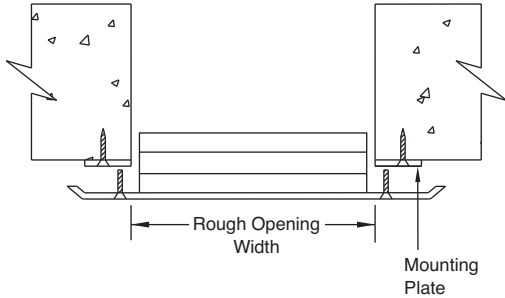

FRONT SECTION

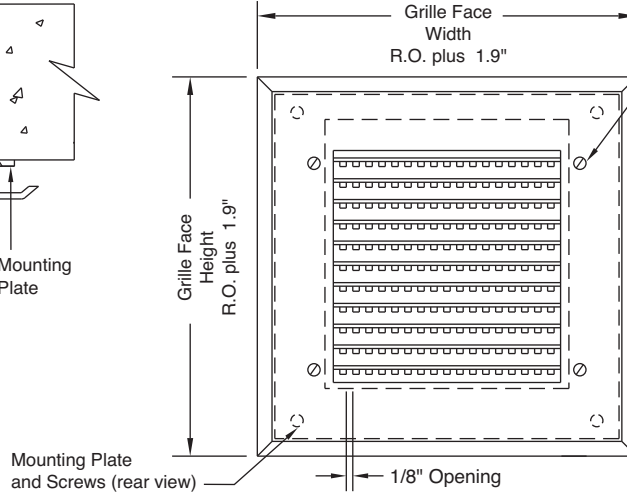

SIDE SECTION

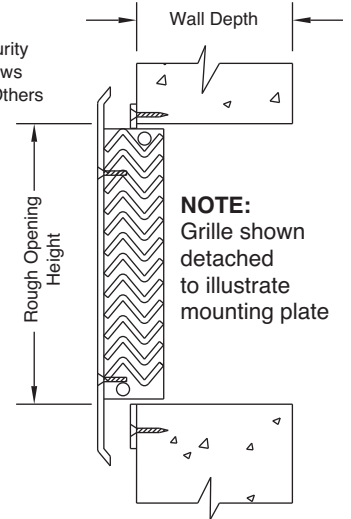

IMPORTANT: It is the specifier's responsibility to properly configure the HVAC system to meet the appropriate level of comfort, safety, security and detention

PRODUCT FEATURES

Face Flange

12 GA (standard)

Material Type

Cold Rolled Steel (standard)

Horizontal/Vertical Mullions

12 GA with 1 7/16" Neck Depth (std)

Finish

White Powder Coat (std)

Other Powder Coat Colors _____

Special Mounting Plate

14 GA Galvanized (standard)

MUST SPECIFY TYPE (BASED ON ROUGH OPENING SIZE) AS PART OF MODEL NUMBER WHEN PLACING ORDER

ROUGH OPENING SIZES (WIDTH X HEIGHT)

Dimensions in Inches	WIDTH									
	5.4	7.4	9.4	11.4	13.4	15.4	17.4	19.4	21.4	
HEIGHT	5.4	A1	B1	C1	D1	E1	F1	G1	H1	J1
	7.4	A2	B2	C2	D2	E2	F2	G2	H2	J2
	9.4	A3	B3	C3	D3	E3	F3	G3	H3	J3
	11.4	A4	B4	C4	D4	E4	F4	G4	H4	J4
	13.4	A5	B5	C5	D5	E5	F5	G5	H5	J5
	15.4	A6	B6	C6	D6	E6	F6	G6	H6	J6
	17.4	A7	B7	C7	D7	E7	F7	G7	H7	J7
	19.4	A8	B8	C8	D8	E8	F8	G8	H8	J8
	21.4	A9	B9	C9	D9	E9	F9	G9	H9	J9

QTY	TYPE	ROUGH OPENING	
		W"	X H"
27	D4	11.4	11.4

SUBMITTAL APPROVAL

Job Name and Location			
Engineer	Date	Factory	Date
Mfr. Rep.	Date	Submitted By	Date

MARCH 2015
 RETROFIT CONSTRUCTION
 S-VENT SECURITY PRODUCTS PAGE 1